

# 1 Cables

We consider the behavior of the transmembrane potential across a long process as a first step toward considering the electrical dynamics of neurons. The cytoplasm acts as one conductor and the extracellular space acts as the second. Let's assume, as is often but not always the case, that the conductance of the extracellular space may be taken as infinite. Then a signal that flows down the center will be attenuated over a length of axon such that the cytoplasmic and membrane impedances (don't forget the capacitance of the membranr) are about equal, i.e., over the length required to form a voltage divider.

**FIGURE - Dendrites.eps**

## 1.1 Basic Scales

For an axon of radius  $a$  with membrane thickness  $L$ , we can estimate this length by equating the cytoplasmic and membrane resistances, i.e.,

$$\rho_c \frac{\lambda}{\pi a^2} \approx \rho_m \frac{L}{2\pi a \lambda} \quad (1.1)$$

or

$$\lambda = \sqrt{\frac{\rho_m a L}{\rho_c 2}} \quad (1.2)$$

Usually the product

$$r_m = \rho_m L \quad (1.3)$$

is denoted as the specific membrane resistance It has typical values of  $r_m = 1$  to  $100 \text{ k}\Omega\text{cm}^2$ , while the cytoplasm has resistances of order  $\rho_c = 30$  to  $300 \text{ }\Omega\text{cm}$ . The spatial attenuation length  $\lambda$  is seen to vary as  $\lambda \propto a^{1/2}$ .

The signals in neurons are confined to a small frequency band, about 10 kHz. Further, the relevant cables are lossy and have a only thin dielectric. Thus it pays to evaluate all of the physical parameters of the system to see which dominate and which may be neglected. Let's consider general expressions for the membrane (transverse) conductance, the membrane capacitance and the axial (what else!) inductance. We consider a model with a membrane, or dielectric layer, that has conductivity  $g$ , permittivity  $\epsilon$ , and permeability  $\mu$ . This arbitrariness of this cable will emphasize that all the bumps in real axons and dendrites can safely be ignored.

**FIGURE - Coaxial-fields.eps**

### 1.1.1 Parallel Capacitance

Our goal is to derive an expression for the time constant of an axon. First, we need to calculate the conductance between the inner and outer conductors, denoted  $G_{ab}$ , in terms of the voltage drop, denoted  $V_{ab}$ , and the current flow,  $I_{ab}$ , where  $G_{ab} = I_{ab}/V_{ab}$ . Then we need to calculate the capacitance between the inner and outer conductors, denoted  $C_{ab}$ , in terms of the voltage drop and the charge difference,  $Q_{ab}$ , where  $C_{ab} = Q_{ab}/V_{ab}$ . The time constant is just the ratio  $\tau = C_{ab}/G_{ab}$ . If we are lucky, geometrical factors will cancel and the result will be simple.

We start with an expression for membrane conductance. From  $\vec{E}(\vec{r}) = -\vec{\nabla}V(\vec{r})$  the voltage from the inside,  $a$ , to the outside,  $b$ , is

$$V_{ab} = \int_a^b \vec{E}(\vec{r}) \cdot d\vec{l} \quad (1.4)$$

where  $d\vec{l}$  defines a path from the inside to outside conductor (it need not follow a radius). From  $\vec{\nabla} \cdot \vec{J}(\vec{r}) + \frac{\partial \rho(\vec{r})}{\partial t} = 0$ ,  $\vec{J}(\vec{r}) = g\vec{E}(\vec{r})$ , and the divergence theorem, i.e.,  $\int_S \vec{J}(\vec{r}) \cdot d\vec{A} = \int_V \vec{\nabla} \cdot \vec{J}(\vec{r}) d^3\vec{r} = \frac{\partial}{\partial t} \int_V \rho(\vec{r}) d^3\vec{r} = \frac{\partial Q_{ab}}{\partial t} = I_{ab}$  where  $\rho$  is the charge density (sorry for the confusion with resistivity) and  $d\vec{A}$  defines a cylindrical shell that the current passes through, the current that flows between the two conductors is

$$I_{ab} = \int_S \vec{J}(\vec{r}) \cdot d\vec{A} = g \int_S \vec{E}(\vec{r}) \cdot d\vec{A} = g \oint_C \vec{E}(\vec{r}) \cdot d\vec{n} \Delta z \quad (1.5)$$

where  $d\vec{n}$  is a unit vector that is normal to a closed path "around" the perimeter of the conductor that defines the shell. The conductance is just

$$G = \frac{I_{ab}}{V_{ab}} = \Delta z \frac{g \oint_C \vec{E}(\vec{r}) \cdot d\vec{n}}{\int_a^b \vec{E}(\vec{r}) \cdot d\vec{l}} \quad (1.6)$$

The final ratio is dimensionless and depends only the geometry. When the cable is a cylinder, the two integrals are equal so the ratio is just 1.

We now consider the expression for membrane capacitance. In the limit of linear response, the electric field leads to a polarization of membrane dipoles, so  $\vec{P}(\vec{r}) = \epsilon_o \chi \vec{E}(\vec{r})$ . We define an auxiliary, or displacement field, by  $\vec{D}(\vec{r}) = \epsilon_o \vec{E}(\vec{r}) + \vec{P}(\vec{r}) = \epsilon_o(1 + \chi) \vec{E}(\vec{r}) \equiv \epsilon \vec{E}(\vec{r})$ . The displacement field obeys  $\vec{\nabla} \cdot \vec{D}(\vec{r}) = \rho$

$$Q_{ab} = \int_V \rho(\vec{r}) d^3\vec{r} = g \int_S \vec{D}(\vec{r}) \cdot d\vec{A} = \epsilon \oint_C \vec{E}(\vec{r}) \cdot d\vec{n} \Delta z \quad (1.7)$$

The capacitance is just

$$C = \frac{Q_{ab}}{V_{ab}} = \Delta z \frac{\epsilon \oint_C \vec{E}(\vec{r}) \cdot d\vec{n}}{\int_a^b \vec{E}(\vec{r}) \cdot d\vec{l}} \quad (1.8)$$

We thus see immediately that the ratio of capacitance to conductance is independent of the geometry, i.e.,

$$\frac{C}{G} = \frac{\epsilon}{g} \quad (1.9)$$

Thus the time constant of the membrane is independent of geometry, i.e.,

$$\tau = \frac{\epsilon_m}{g_m} = \epsilon_m \rho_m = \frac{\epsilon_m}{L} \rho_m L = c_m r_m \quad (1.10)$$

where  $c_m \equiv \frac{\epsilon_m}{L} \approx 1 \frac{\mu F}{cm^2}$  ( $L$  is the thickness of the membrane here). Note that we immediately see that the ratio of the resistive to the capacitive impedance is:

$$\left| \frac{Z_{C_m}}{Z_{R_m}} \right| = \left| \frac{G}{i2\pi f C} \right| = \frac{1}{2\pi f \tau} \quad (1.11)$$

so that the time-constant of the membrane sets the scale between resistive versus capacitive current flow.

### 1.1.2 Series Inductance

We have one bit of business left to calculate, the series inductance. From  $\vec{J}(\vec{r}) = \vec{\nabla} \otimes \vec{H}(\vec{r})$  and Stokes theorem, i.e.,  $\int_S (\vec{\nabla} \otimes \vec{H}(\vec{r})) \cdot d\vec{A} = \oint_C \vec{H}(\vec{r}) \cdot d\vec{l}$ , the current that flows along  $\hat{z}$  in either conductor is

$$I_z = \int_S \vec{J}(\vec{r}) \cdot d\vec{A} = \oint_C \vec{H}(\vec{r}) \cdot d\vec{l} \quad (1.12)$$

We also know that the magnetic flux,  $\psi$ , that is contained within the cable is found by intergating over a cylindrical shell

$$\psi = \int_S \vec{B}(\vec{r}) \cdot d\vec{A} = \mu \int_S \vec{H}(\vec{r}) \cdot d\vec{A} = \mu \int_a^b \vec{H}(\vec{r}) \cdot d\vec{n} \Delta z \quad (1.13)$$

Thus the inductance,  $L$ , is give by

$$L = \frac{\psi}{I_z} = \Delta z \frac{\mu \int_a^b \vec{H}(\vec{r}) \cdot d\vec{n}}{\int_C \vec{H}(\vec{r}) \cdot d\vec{l}} \quad (1.14)$$

We can recast this in terms of the electric field by noting that  $\vec{E}(\vec{r})$  and  $\vec{H}(\vec{r})$  are orthogonal to each other, so that  $\vec{H}(\vec{r}) \propto \vec{E}(\vec{r}) \otimes \hat{z}$ . Then

$$\begin{aligned} L &= \Delta z \frac{\mu \int_a^b \vec{E}(\vec{r}) \otimes \hat{z} \cdot d\vec{n}}{\oint_C \vec{E}(\vec{r}) \otimes \hat{z} \cdot d\vec{l}} \\ &= \Delta z \frac{\mu \int_a^b \vec{E}(\vec{r}) \cdot \hat{z} \otimes d\vec{n}}{\oint_C \vec{E}(\vec{r}) \cdot \hat{z} \otimes d\vec{l}} \\ &= \Delta z \frac{\mu \int_a^b \vec{E}(\vec{r}) \cdot d\vec{l}}{\oint_C \vec{E}(\vec{r}) \cdot d\vec{n}} \end{aligned} \quad (1.15)$$

where we used  $\vec{A} \cdot \vec{B} \otimes \vec{C} = \vec{B} \cdot \vec{C} \otimes \vec{A} = \vec{C} \cdot \vec{A} \otimes \vec{B}$ . We now see, quite generally, that the product of the capacitance per unit length,  $C/\Delta z$  and the inductance per unit length,  $L/\Delta z$ , is

$$\frac{C}{\Delta z} \frac{L}{\Delta z} = \mu\epsilon \quad (1.16)$$

Let's compare the impedance of the series inductance with that the series resistance (we now assume a loss in the inner conductor) over a distance of one space constant,  $\lambda$ , i.e.,

$$\begin{aligned} \left| \frac{Z_{L_s}}{Z_{R_s}} \right| &= \left| \frac{i2\pi f L}{R_s} \right| = \frac{2\pi f \mu\epsilon \lambda^2}{C R_s} = \frac{2\pi f \tau}{c^2} \frac{\lambda^2}{C R_m \tau} \frac{R_m}{R_c} \\ &= \frac{2\pi f \tau}{c^2} \left( \frac{\lambda}{\tau} \right)^2 \frac{R_m}{R_c} \\ &\approx 2\pi f \tau \left( \frac{v}{c} \right)^2 \end{aligned} \quad (1.17)$$

where we used  $\sqrt{\mu\epsilon} = 1/c$  where  $c$  is the speed of light,  $R_m \approx R_c$  when  $\Delta z = \lambda$ , and  $v \equiv \frac{\lambda}{\tau}$  as a measure of passive speed. The ratio of impedances is extraordinarily small, we we may safely ignore series inductance in a model of the cell.

## 1.2 Cable Equation

We can now just consider a model with resistances and capacitances and write down a lumped parameter model for a lossy cable. The exact equation for a cable can be considered by writing the circuit equations for a segment of length  $\Delta x$  and letting  $\Delta x \rightarrow 0$ . We get

$$\tau \frac{\partial V(x, t)}{\partial t} + V(x, t) - \lambda^2 \frac{\partial^2 V(x, t)}{\partial x^2} = \frac{r_m}{2\pi a} I_m(x, t) \quad (1.18)$$

We have included the possibility of additional membrane currents, denoted  $I_m$  in units of Amperes per unit length; these will become evident when we study action potential propagation.

**FIGURE - Linear-cable.eps**

### 1.2.1 Steady State Response

A particularly simple case to consider is the steady state response to the continuous injection of current at a point. The cable equation turns into Helmholtz's equation ( $\lambda$  plays the role of ' $k$ '), i.e.,

$$V(x) - \lambda^2 \frac{\partial^2 V(x)}{\partial x^2} = \frac{r_m}{2\pi a} I_m(x) \quad (1.19)$$

and we know that the solutions are of the form

$$V(x) = Ae^{\frac{x}{\lambda}} + Be^{-\frac{x}{\lambda}} + C \quad (1.20)$$

where here the  $A, B, C$ s are constants. For the case of current injected at a spot into an infinitely long uniform cable, , i.e,  $I_m(x) = I_o\delta(x)$ , the change in voltage is

$$V(x) = \frac{I_o}{2\lambda} \frac{r_m}{2\pi a} e^{-\frac{|x|}{\lambda}} + V(\infty) \quad (1.21)$$

### FIGURE - Steady-state-dc.eps

Thus, as we claimed above, we see directly that  $\lambda$  scales the length of the electrical disturbance. We also see that the input resistance scales as

$$R = \frac{V(0)}{I_o} = \frac{\sqrt{2}}{4\pi} \sqrt{\rho_c r_m} a^{-3/2} \quad (1.22)$$

Thus the resistance goes up faster than linear as the radius of the process decreases. To the extent that large resistances are a good thing, as least as far as not loading down the soma, one cannot be too thin ... .

We can push this result into the frequency domain to see what the low pass filtering characteristics of the cable look like. The simplest way to do this is to take the Fourier transform, with respect to time, of the original cable equation. We get

$$i\tau\omega\tilde{V}(x,\omega) + \tilde{V}(x,\omega) - \lambda^2 \frac{\partial^2 \tilde{V}(x,\omega)}{\partial x^2} = \frac{r_m}{2\pi a} \tilde{I}_m(x,\omega) \quad (1.23)$$

or

$$(1 + i\omega\tau)\tilde{V}(x,\omega) - \lambda^2 \frac{\partial^2 \tilde{V}(x,\omega)}{\partial x^2} = \frac{r_m}{2\pi a} \tilde{I}_m(x,\omega) \quad (1.24)$$

This looks exactly like the Helmholtz equation if we make the substitutions

$$r_m \leftarrow \frac{r_m}{1 + i\omega\tau} \quad (1.25)$$

$$\lambda \leftarrow \frac{r_m}{\sqrt{1 + i\omega\tau}} \quad (1.26)$$

The resistance is generalized to a steady-state impedance with

$$Z(\omega) = R \frac{1}{\sqrt{1 + i\omega\tau}} = R \frac{e^{-\frac{i}{2}\tan^{-1}(\omega\tau)}}{(1 + (\omega\tau)^2)^{\frac{1}{4}}} \quad (1.27)$$

It is interesting that the impedance varies as  $Z \sim R/\sqrt{\omega\tau}$ , in contrast to the  $Z \sim R/(\omega\tau)$  dependence for a lumped RC circuit. This was recently seen in motoneurons. Thus long cables provide a very soft filtering effect.

### FIGURE - Facial-motoneurons.eps

## 1.2.2 General Response

The full cable equation is simple to evaluate once you realize that this is really the diffusion equation in terms of the function  $U(x, t)$ , with

$$V(x, t) = e^{-\frac{t}{\tau}} U(x, t) \quad (1.28)$$

where  $\frac{\lambda^2}{\tau} = \frac{a}{\rho_c c_m}$  plays the role of the diffusion constant. The homogeneous part of the cable equation becomes

$$\lambda^2 \frac{\partial^2 U(x, t)}{\partial x^2} - \tau \frac{\partial U(x, t)}{\partial t} = 0 \quad (1.29)$$

We can write down the delta function response directly. That is, for an impulse of charge so that  $I_m(x, t) = Q_o \delta(x) \delta(t)$ , the voltage evolves as

$$V(x, t) = \frac{Q_o}{\tau} \frac{r_m}{2\pi a} \sqrt{\frac{\tau}{4\pi\lambda^2 t}} e^{-\frac{t}{\tau} - \frac{x^2\tau}{4\lambda^2 t}} \quad (1.30)$$

There are two essential aspects of the response to consider. The first is that the voltage at the injection site initially decay faster than  $\tau_m$  as current flows into the cable and and charge it. At later times all locations of the cable essentially discharge together and the decay is exponential. This behavior can be seen from plots of the calculated response at various distances from the origin, and in the data of Rall, who spent much effort on the issue of cables.

**FIGURE - Cable-solutions.eps**

**FIGURE - Cable-decay.eps**

The second point is that the pulse is decaying as it spreads, and thus has the appearance of a front. We can ask where the front of the pulse is by calculating  $\frac{\partial V(x, t)}{\partial t} = 0$ . We rewrite our solution of the cable equation with all of the time and space dependent terms in the exponent, so that

$$V(x, t) = V(0) e^{-\frac{1}{2} \ln \frac{t}{\tau} - \frac{t}{\tau} - \frac{x^2\tau}{4\lambda^2 t}} \quad (1.31)$$

Thus  $\frac{\partial V(x, t)}{\partial t} = \frac{\partial V_o e^{f(x, t)}}{\partial t} = V_o e^{f(x, t)} \frac{\partial f(x, t)}{\partial t} = 0$  implies

$$\frac{d \left( \frac{1}{2} \ln \frac{t}{\tau} + \frac{t}{\tau} + \frac{x^2\tau}{4\lambda^2 t} \right)}{dt} = 0 \quad (1.32)$$

$$\frac{\tau}{2} + t^2 - \frac{x^2\tau^2}{4\lambda^2} = 0 \quad (1.33)$$

which gives

$$t_{max} = \frac{\tau}{2} \left( \sqrt{\frac{1}{4} + \frac{x^2}{\lambda^2}} - \frac{1}{2} \right) \approx \frac{\tau}{2} \frac{|x|}{\lambda} \quad (1.34)$$

The ratio  $\frac{|x|}{t_{max}} = \frac{2\lambda}{\tau}$  is the speed of the peak of the voltage pulse.

### 1.3 Space-Time Measurements of Passive Decay

Passive spread is seen very nicely in the data of Fromhertz, who performed the first direct measure of passive decay in an invertebrate axon. The technique they used was voltage sensitive dyes. We will take a brief interlude to discuss the preparation, the axon of large leech neurons, and the technique, optical measurements of axons stained with voltage sensitive dyes.

#### **TWO FIGURES - Imaging with voltage sensitive dyes - from CSHL summer school**

They used this data to infer the membrane and cytoplasmic resistances since they could fit the entire space-time waveform of the passive spread. There are two unknown parameters,  $\lambda$  and  $\tau$ , and these are well constrained by the fit (qualitatively, the spread of the response determines  $\frac{\lambda^2}{\tau}$  and the speed of the front of the hyperpolarization determines  $\frac{\lambda}{\tau}$ ). From  $\lambda$  and  $\tau$ , they get

$$r_m = \rho_m L = \left(\frac{1}{c_m}\right) \tau \approx 2 \cdot 10^4 \Omega \cdot cm^2 \quad (1.35)$$

and

$$\rho_c = \left(\frac{1}{c_m}\right) \frac{a}{2} \frac{\tau}{\lambda^2} \approx 2.5 \cdot 10^2 \Omega \cdot cm \quad (1.36)$$

They also had data for the active (regenerative) spread in the same axon, which as we will soon see, imposes constraints that over determine their model. Fromherz found that the values were much larger than those in the squid axon, 7-times for  $\rho_c$  and 12-times for the  $r_m$  at rest! Proof that a leech is not a squid!

#### **FIGURE - Leech ganglion - from CSHL summer school**

#### **FIGURE - Fromhertz experiment - from CSHL summer school**

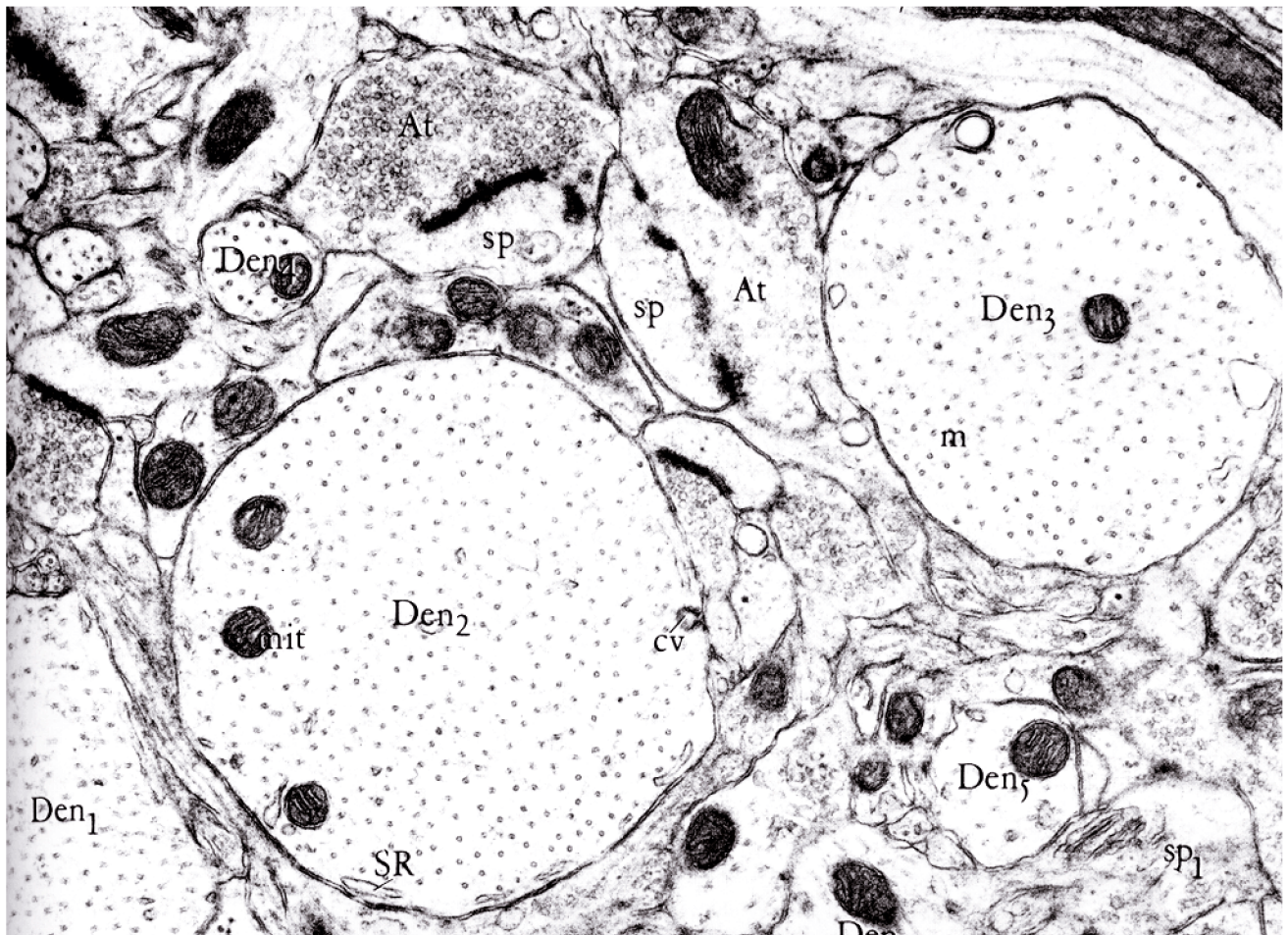
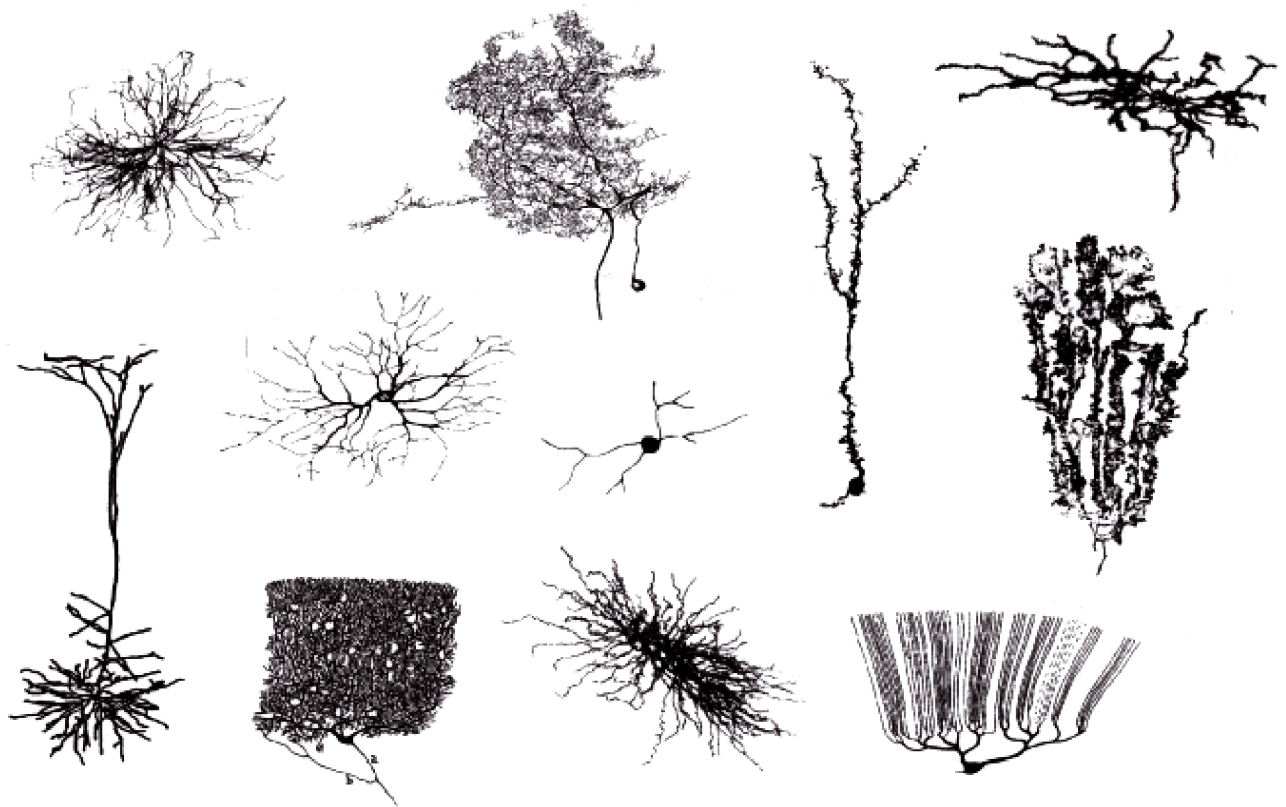



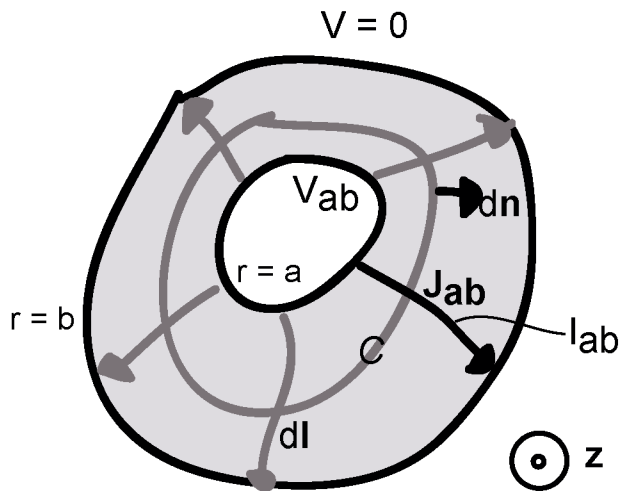
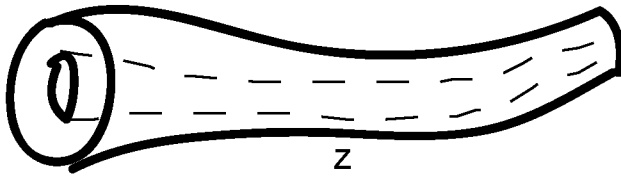

for Conductance ( $G$ )

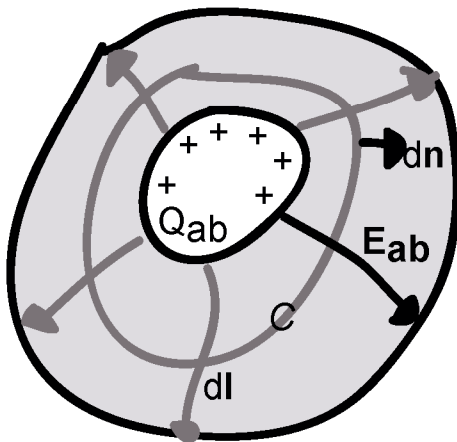

for Capacitance ( $C$ )

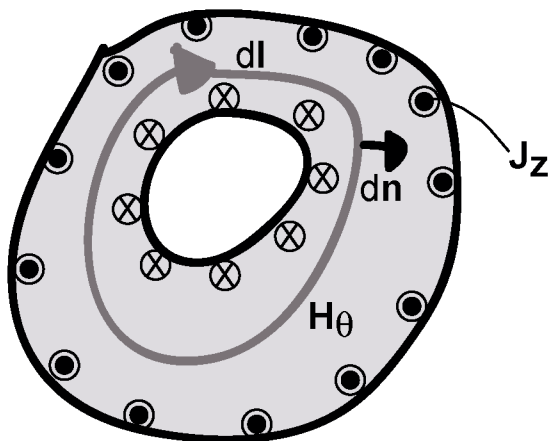

for Inductance ( $L$ )

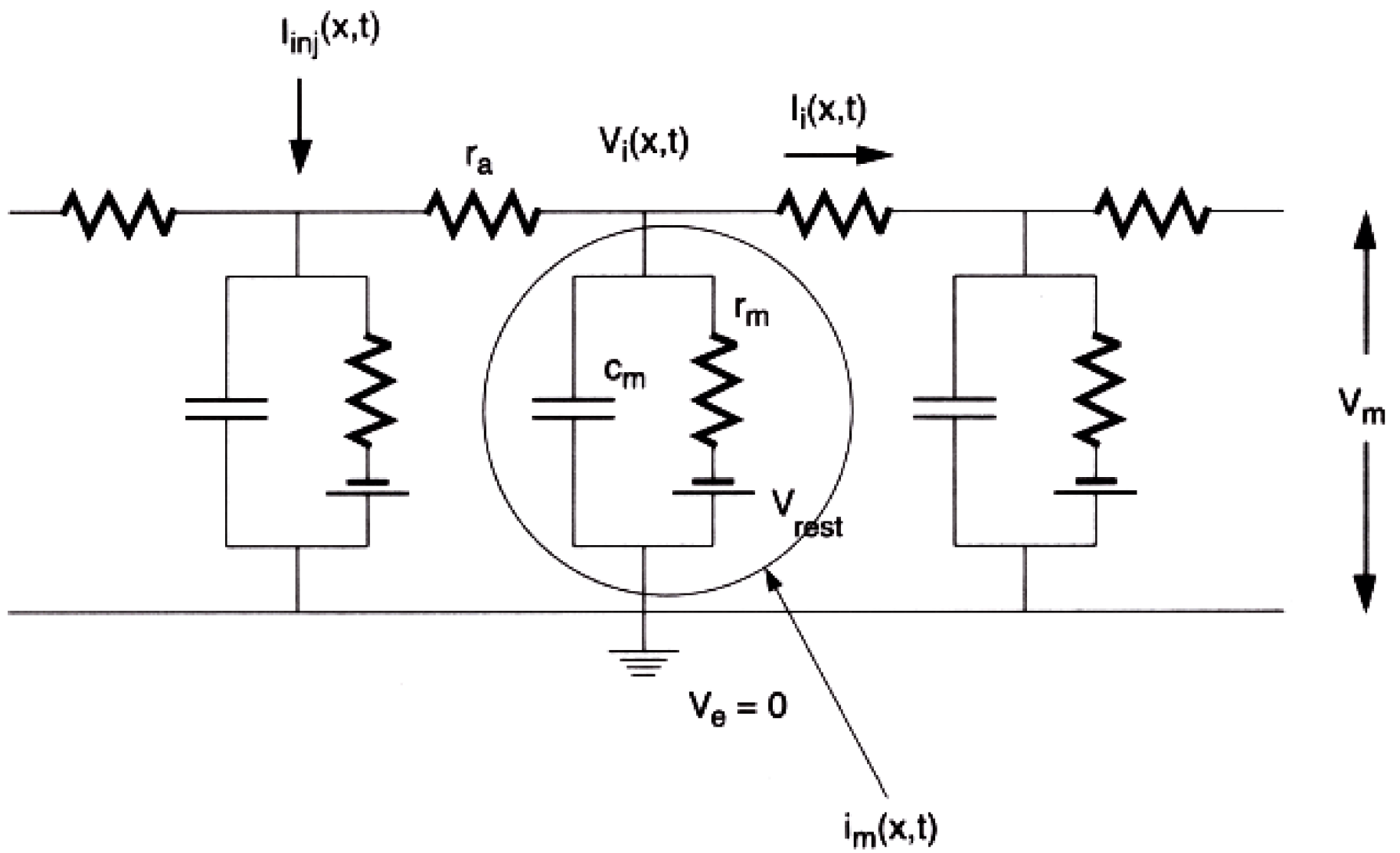

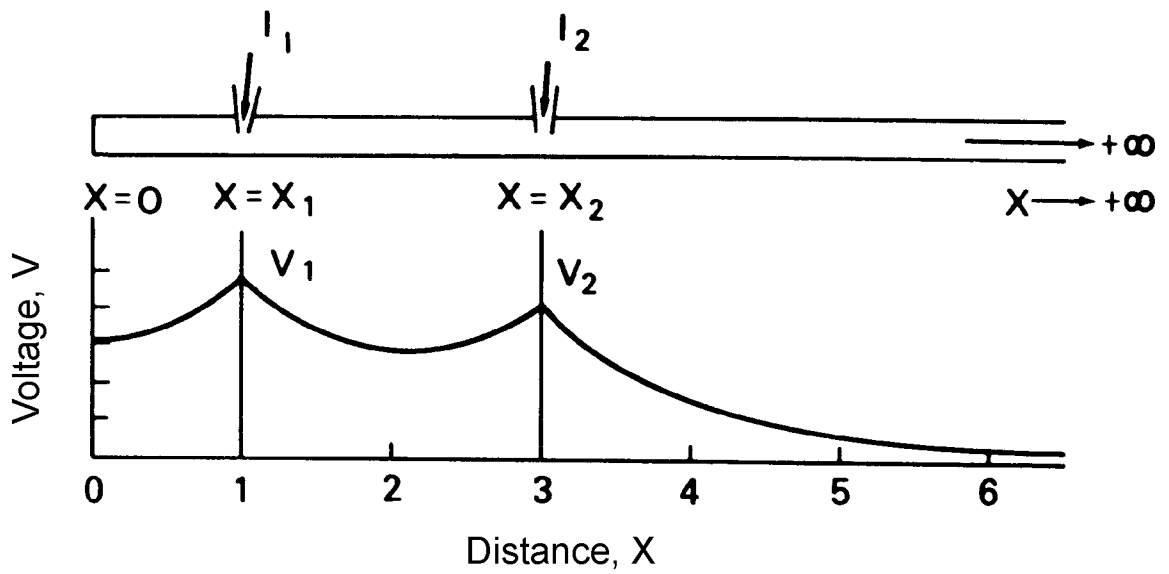
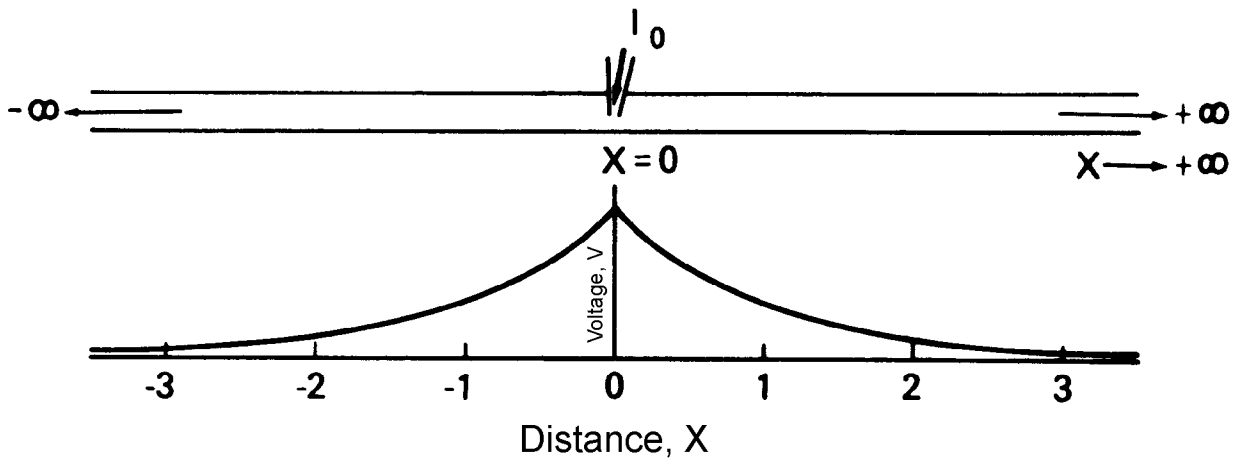
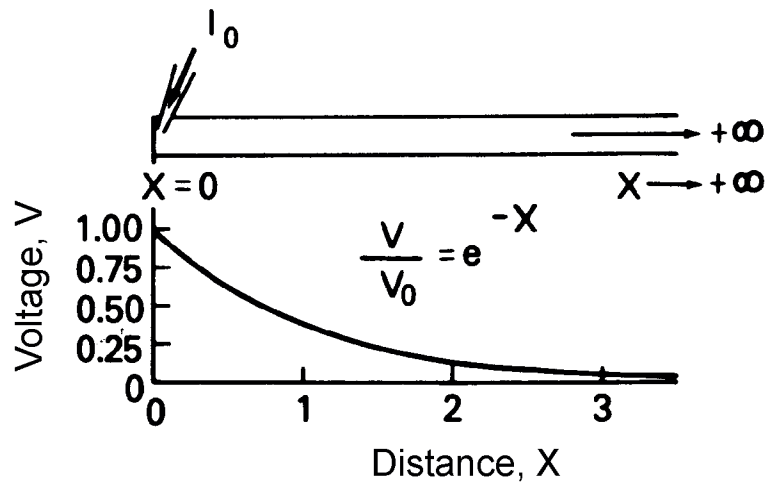

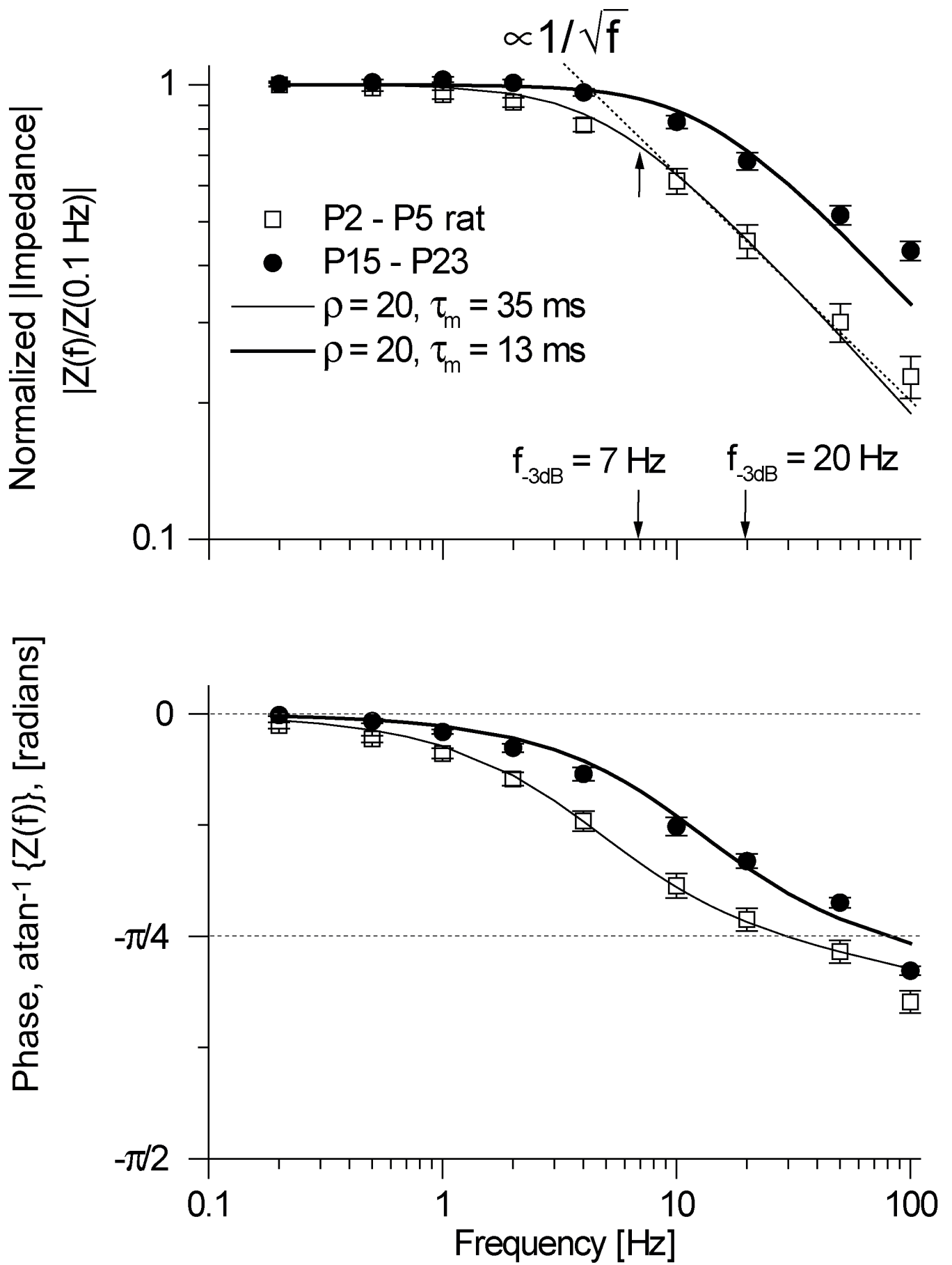

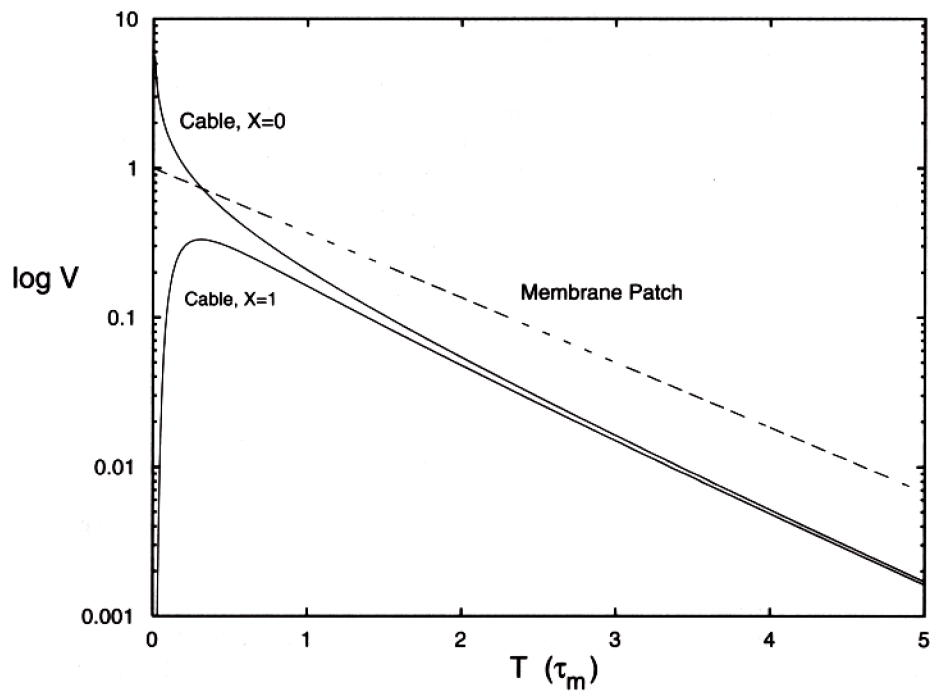
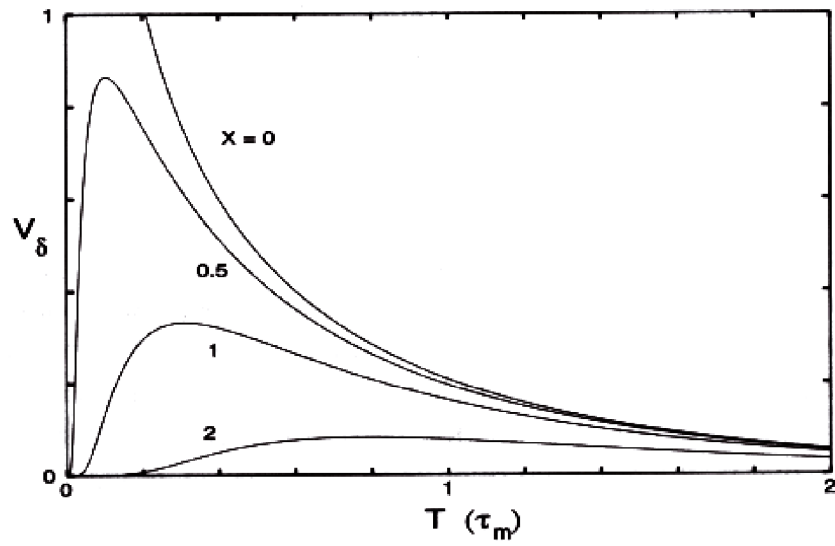
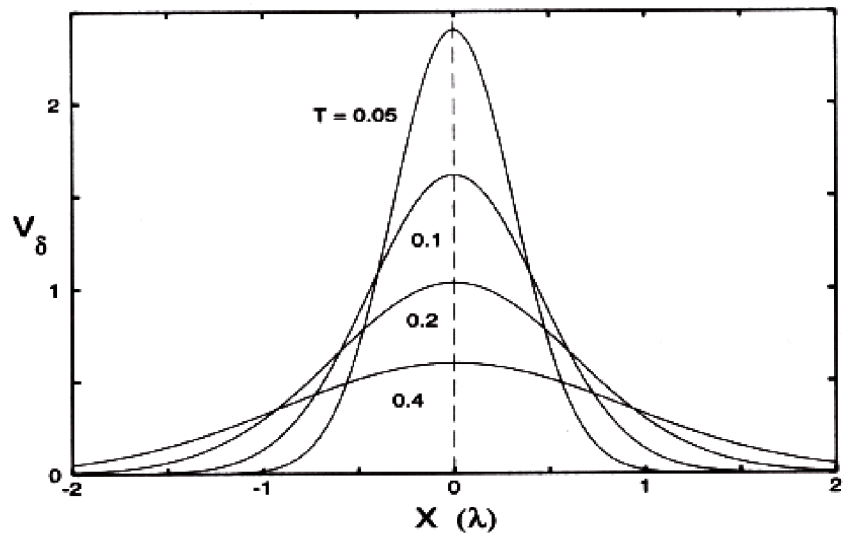

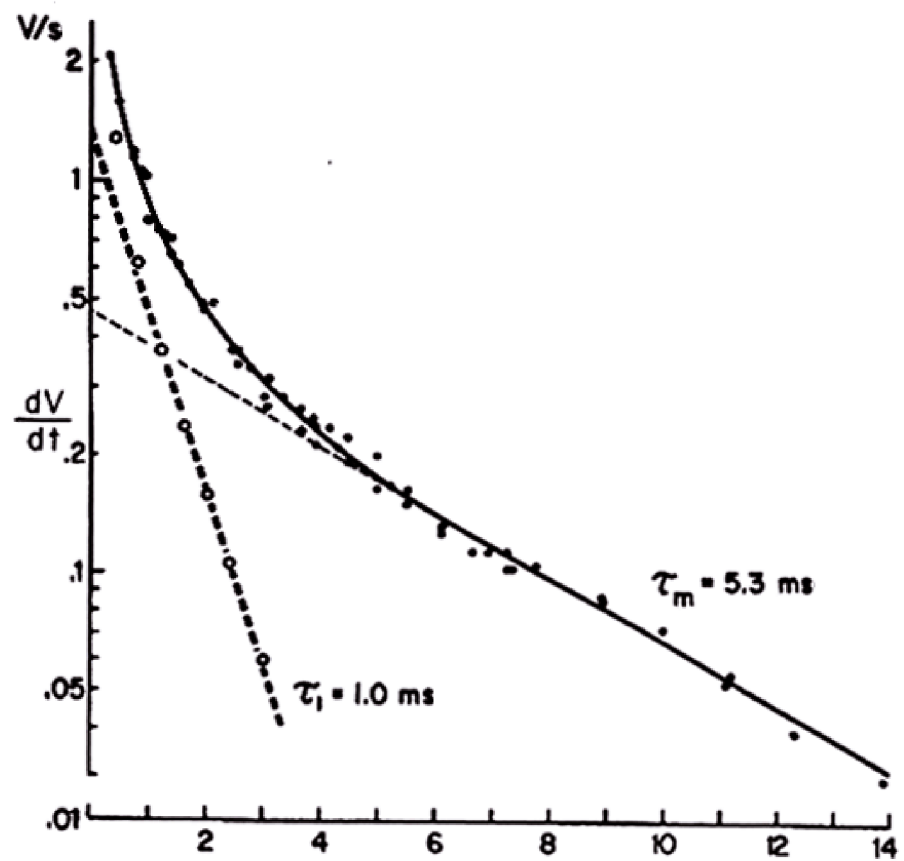
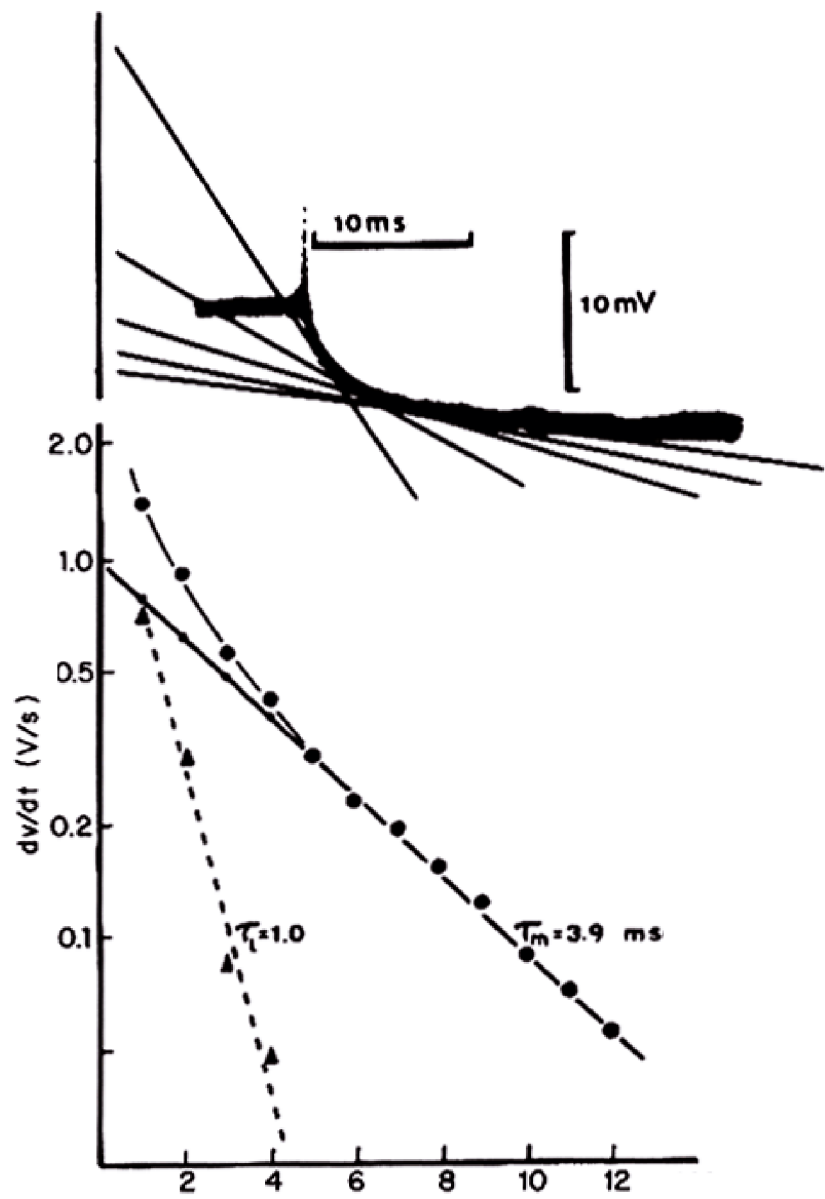

Action Potential in Giant Squid Axon  
Merocyanine 540 (1973)

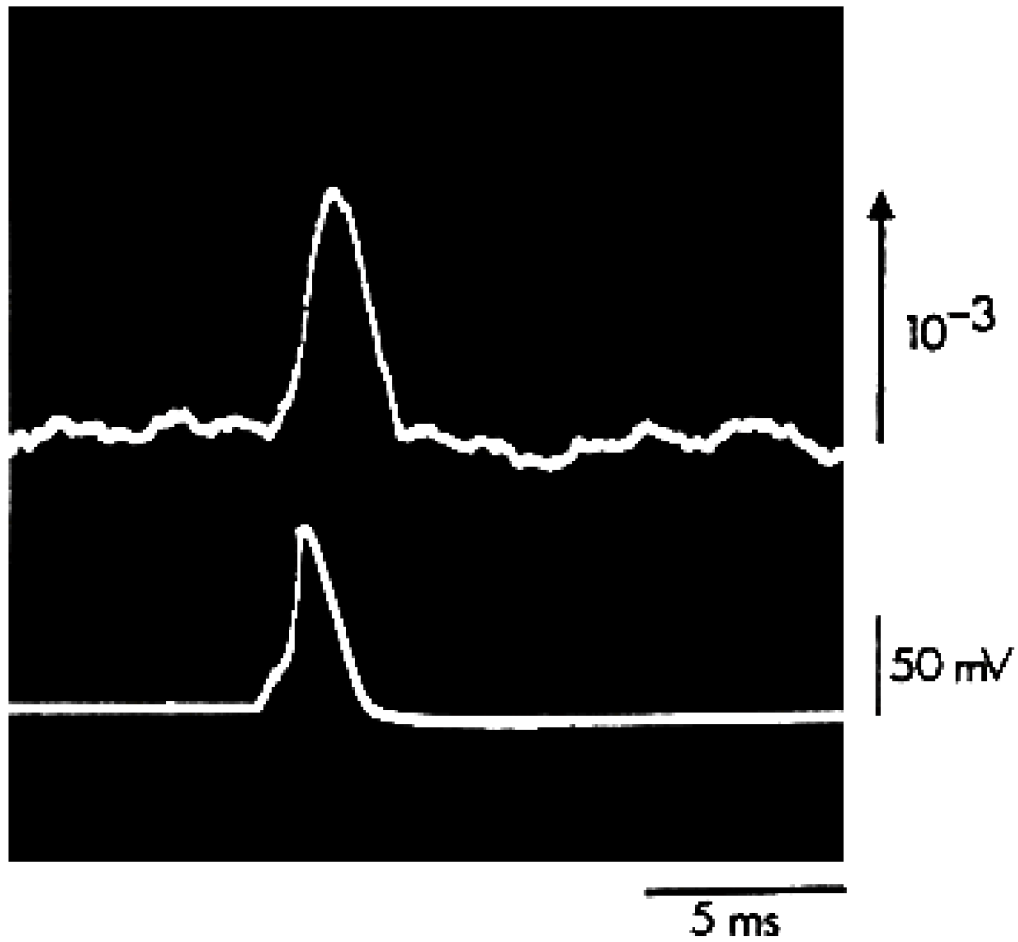

Rotating Waves in Turtle Visual Cortex  
RH795 (aminostyryl)pyridinium (1997)

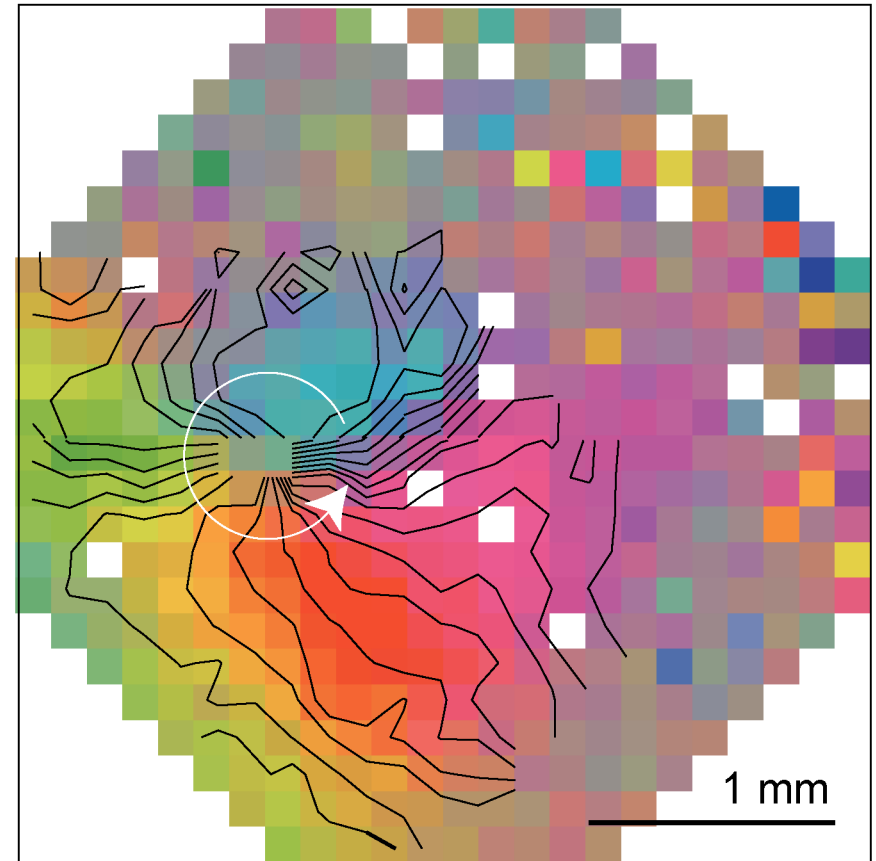

# di-4-ANEPPS (Leslie Loew) - A popular Stark effect dye (optical changes per 100 mV across a bilayer)

Transmission

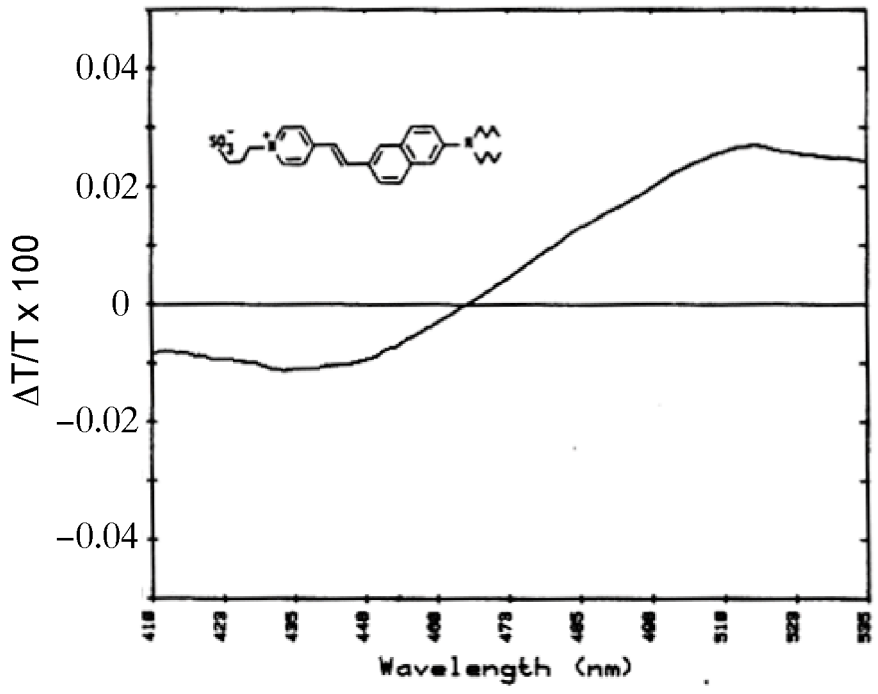

Emission at Fixed Excitation Wavelength

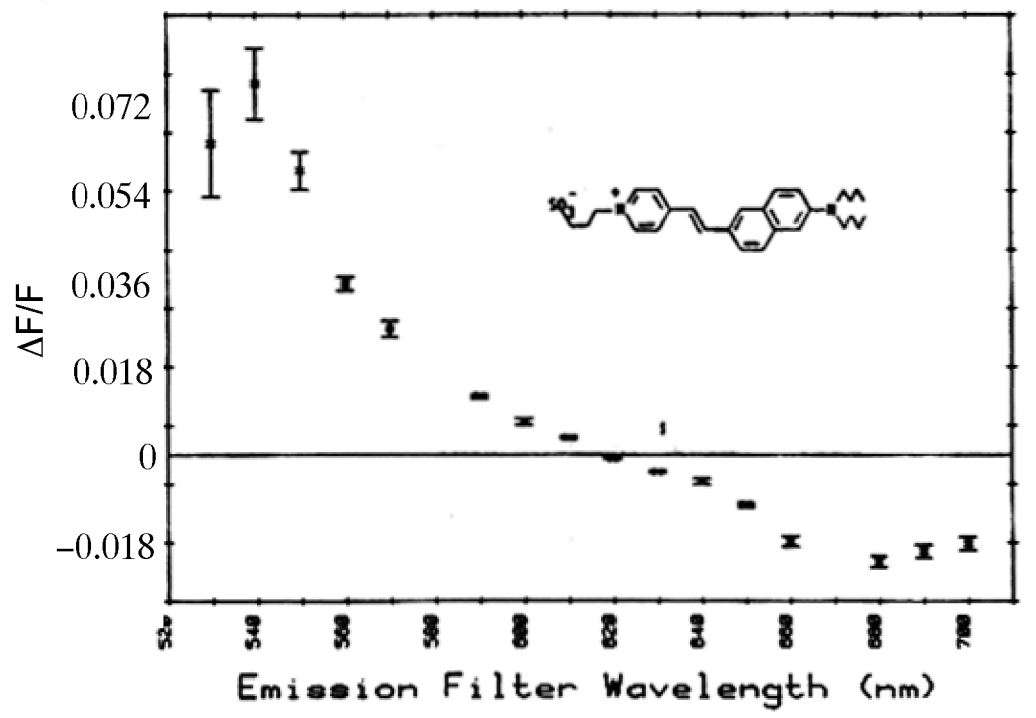



← Ant

Post →

Connectives

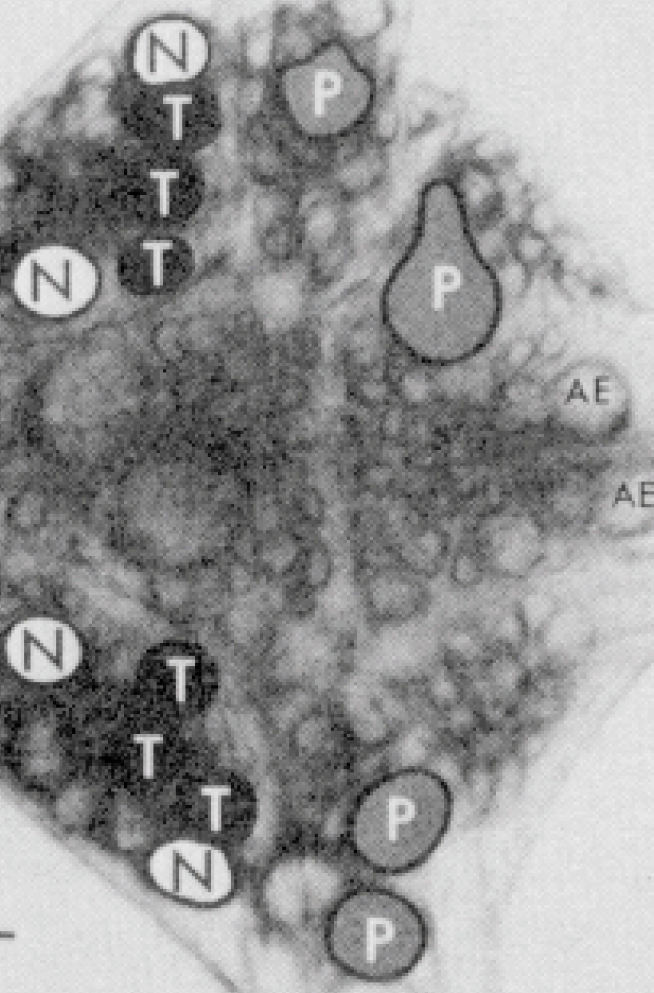

250 μ

Roots

# Cable Properties of a Leech Neurite Probed with Voltage Sensitive Dye (Fromherz and Muller, 1994)

